

Energy Ratings Request Form - Window

Email completed forms to:
energy.ratings@aperture-trading.com

Tel: 01623 443200
www.aperture-trading.com



Company:

Account No.

Contact Name:

Tel:

Your Reference:

Requested date: / /

Required date: / /

METHOD OF COMPLIANCE

- BFRC WER Rating
 EN 10077 U-Value Compliance

Please tick all of the appropriate following options:

Your reinforcement selection must comply with Aperture Fabrication Guidelines

OUTER FRAME	4F1	4F2	4F5
	<input type="checkbox"/>	<input type="checkbox"/>	<input type="checkbox"/>
Reinforcement	NONE	PTI	STEEL
	<input type="checkbox"/>	<input type="checkbox"/>	<input type="checkbox"/>

VENT	4V6	4TT1
	<input type="checkbox"/>	<input type="checkbox"/>
Reinforcement	NONE	STEEL
	<input type="checkbox"/>	<input type="checkbox"/>

TRANSOM	4OL1	4OL2	
	<input type="checkbox"/>	<input type="checkbox"/>	
Reinforcement	NONE	PTI	STEEL
	<input type="checkbox"/>	<input type="checkbox"/>	<input type="checkbox"/>

BEAD	4SJB28	Triple	TCJB
	<input type="checkbox"/>	<input type="checkbox"/>	<input type="checkbox"/>

Please refer to overleaf for product cross-sections

GLASS

Inner

Outer

Centre *(Use for triple glazing only)*

SPACER BAR

SECONDARY SEALANT DEPTH mm

TARGET U-VALUE W/m²K

TARGET WER RATING

Please tick as required

A+ A B C

Please note we will endeavour to fulfil your enquiry within 5 working days.



Energy Ratings Request Form - Window

OUTER FRAME

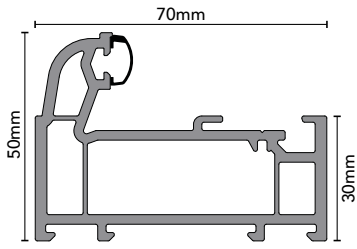

4F1
Slim Outer Frame

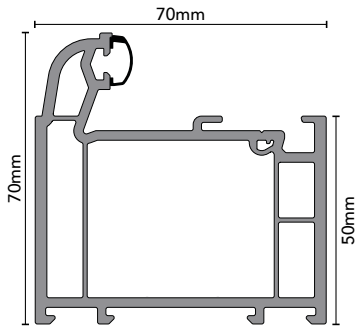

4F2
Large Outer Frame

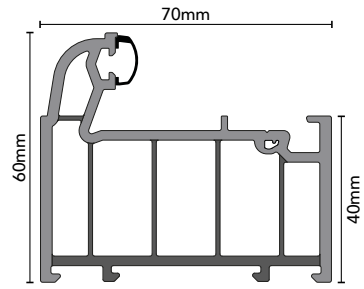

4F5
Multi-Chambered Outer Frame

VENT

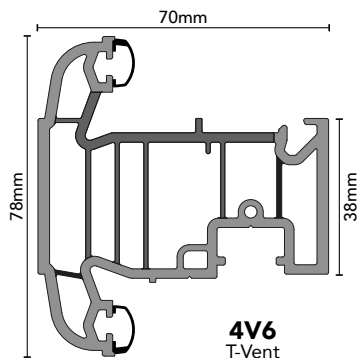

4V6
T-Vent

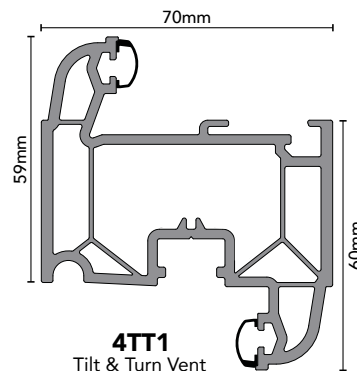

4TT1
Tilt & Turn Vent

TRANSOM

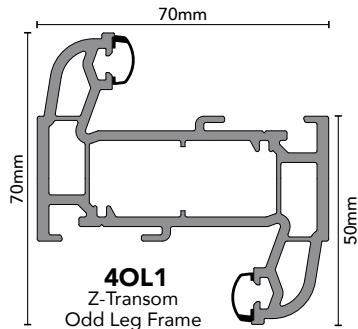

4OL1
Z-Transom
Odd Leg Frame

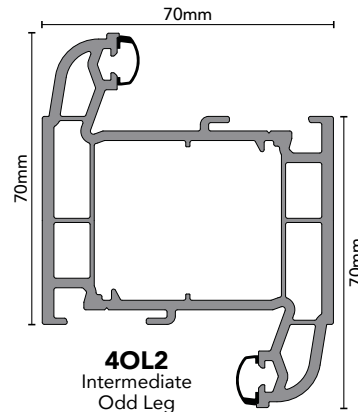

4OL2
Intermediate
Odd Leg

BEAD



4SJB28
28mm Sculptured
(J Bead)



TCJB
36mm Triple
Glazing Bead