

# Energy Ratings Request Form - Window

Email completed forms to:  
**energy.ratings@aperture-trading.com**

Tel: 01623 443200  
**www.aperture-trading.com**



Company: .....

Account No. ....

Contact Name: .....

Tel: .....

Your Reference: .....

## METHOD OF COMPLIANCE

- BFRC WER Rating  
 EN 10077 U-Value Compliance

Requested date: ..... / ..... / .....

Required date: ..... / ..... / .....

### OUTER FRAME

Round Feature 8F11  8F13  8F11E  8F13E

Square Feature 8F31  8F33  8F31E  8F33E

8MF1  8MF3  8MF1E  8MF3E

### VENT

Round Feature 8V12  8TT11

Square Feature 8V32  8TT31  8LV32

### TRANSOM

8MT1  8MT1E

### BEAD

8SB28  8CB28  8RB28  Triple 8SB44  8CB44  8RB44

**Please refer to overleaf for product cross-sections**

### GLASS

Inner .....

Outer .....

Centre *(Use for triple glazing only)* .....

### SPACER BAR

.....

**SECONDARY SEALANT DEPTH** .....

mm

**TARGET U-VALUE** .....

W/m<sup>2</sup>K

### TARGET WER RATING

*Please tick as required*

A+  A  B  C

Please note we will endeavour to fulfil your enquiry within 5 working days.



# Energy Ratings Request Form - Window

## OUTER FRAME

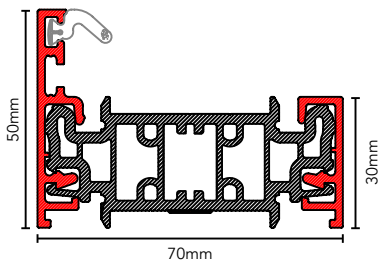

**8F31**

50mm Standard Outer Frame

**8F11** (Round Feature)

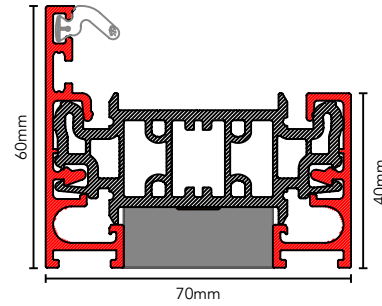

**8F33**

60mm Standard Outer Frame

**8F13** (Round Feature)

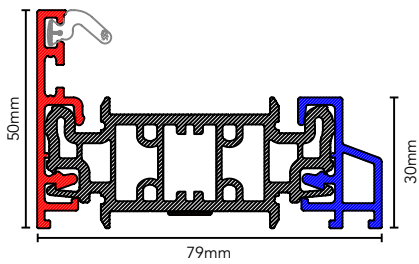

**8F31E**

50mm Extended Outer Frame

**8F11E** (Round Feature)

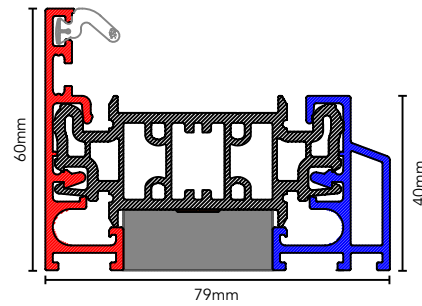

**8F33E**

60mm Extended Outer Frame

**8F13E** (Round Feature)

## OUTER FRAME

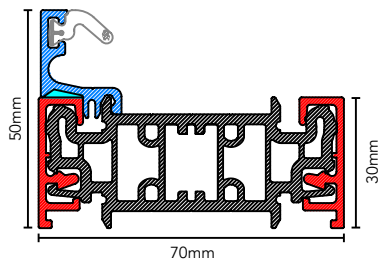

**8MF1**

50mm Multi-Frame

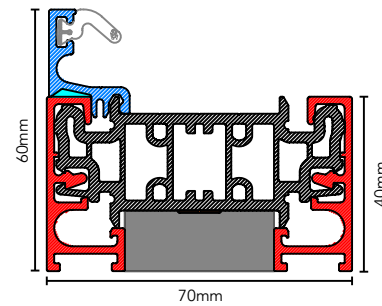

**8MF3**

60mm Multi-Frame

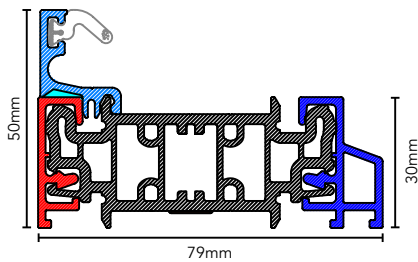

**8MF1E**

50mm Extended Multi-Frame

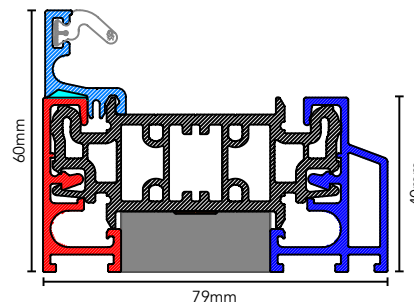

**8MF3E**

60mm Extended Multi-Frame

# Energy Ratings Request Form - Window

## VENT

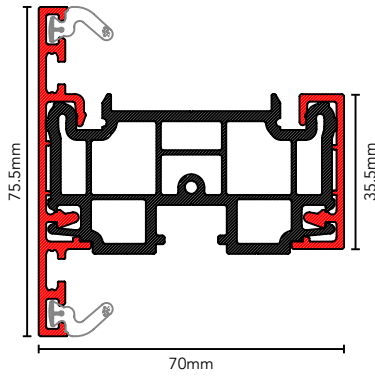

**8V32**  
Casement Vent  
**8V12** (Round Feature)

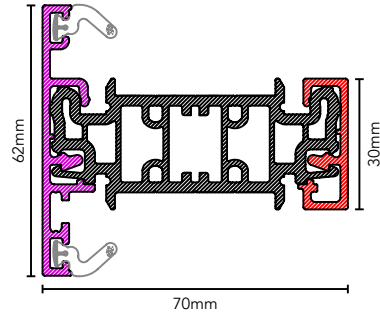

**8LV32**  
Slim Casement Vent

## TRANSOM

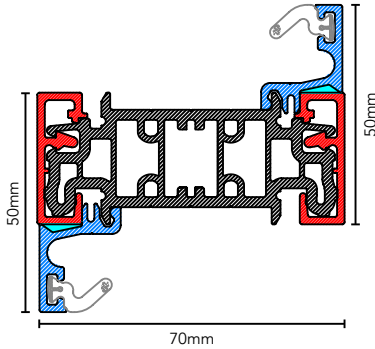

**8MT1**  
70mm Multi-Transom

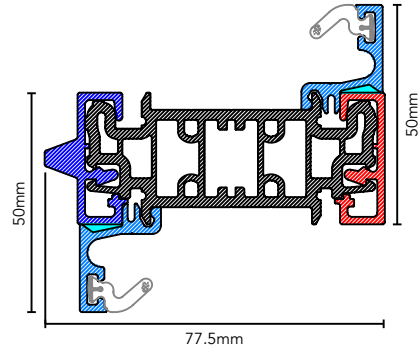

**8MT1E**  
70mm Multi-Transom (Extended)

## TILT AND TURN

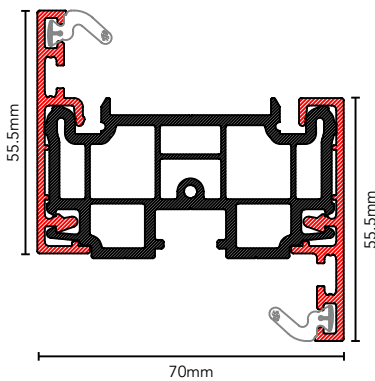

**8TT31**  
T&T Sash  
**8TT11** (Round Feature)

## BEAD

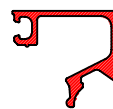

**8WSB28**  
Window Bead  
(Square)  
28mm Glazing

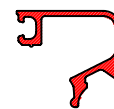

**8WRB28**  
Window Bead  
(Pencil Round)  
28mm Glazing

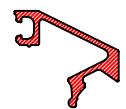

**8WCB28**  
Window Bead  
(Chamfered)  
28mm Glazing

Used On Vertical Sections Only



**8WSB44**  
Window Bead  
(Square)  
44mm Glazing



**8WRB44**  
Window Bead  
(Pencil Round)  
44mm Glazing



**8WCB44**  
Window Bead  
(Chamfered)  
44mm Glazing

Used On Vertical Sections Only